

TECHNICAL DATA

BOMAG VARIOCONTROL (BVC)

BW 213 BVC-5, BW 226 BVC-5

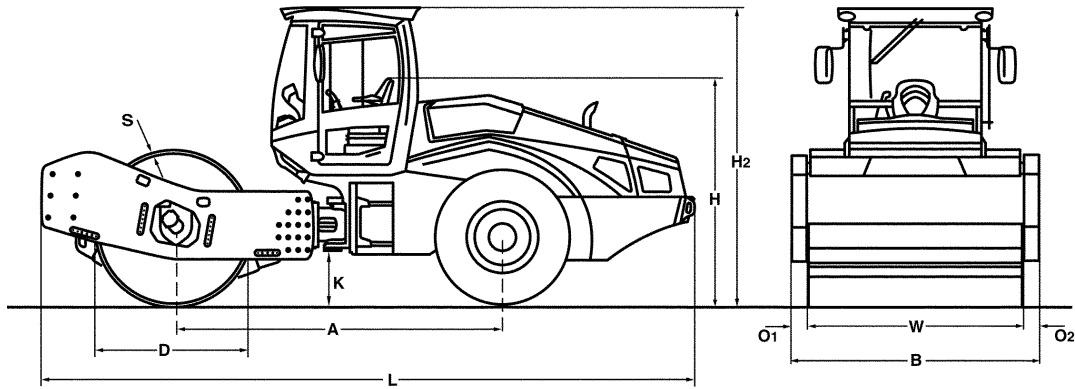



Dimensions in mm

	A	B	D	H	H2	K	L	O1	O2	S	W
BW 213 BVC-5	2975	2270	1500	2250	2990	490	5875	70	70	30	2130
BW 226 BVC-5	3355	2500	1600	2339	3078	430	6740	185	185	40	2130

Shipping dimensions in m3

BW 213 BVC-5
BW 226 BVC-5

without ROPS

30,007
 39,412

with ROPS

39,875
 51,864

Machine type	Compaction output (m3/h)			
	Rock fill	Gravel, sand	Mixed soil	Silt, clay
BW 213 BVC-5	700-1400	480-960	360-720	210-420
BW 226 BVC-5	1180-2120	980-1800	700-1350	385-770

Machine type	Compacted layer thickness (m)			
	Rock fill	Gravel, sand	Mixed soil	Silt, clay
BW 213 BVC-5	1,20	0,80	0,60	0,30
BW 226 BVC-5	2,00	1,60	1,10	0,50

Technical Data**BOMAG
BW 213 BVC-5****BOMAG
BW 226 BVC-5****Weights**

Grossweight	kg	16.170	27.580
Operating weight CECE w. ROPS-cabin	kg	13.820	25.880
Axle load, drum CECE	kg	8.500	17.930
Axle load, wheels CECE	kg	5.320	7.950
Static linear load CECE	kg/cm	39,9	84,2

Dimensions

Working width	mm	2.130	2.130
Track radius, inner	mm	3.680	4.260

Driving Characteristics

Speed	km/h	0- 12,0	0- 9,0
Max. gradeability without/with vibr.	%	58/55	50/47

Drive

Engine manufacturer		Deutz	Deutz
Type		TCD 2012 L04 2V	TCD 2012 L06
Emission stage		Stage IIIa / TIER3	Stage IIIa / TIER3
Cooling		Liquid	water
Number of cylinders		4	6
Performance ISO 3046	kW	103,0	150,0
Performance SAE J 1995	hp	140,0	202,0
Speed	min-1	2.400	2.200
Fuel		Diesel	Diesel
Electric equipment	V	12	12
Drive system		hydrost.	hydrost.
Drum driven		standard	standard

Drums and Tyres

Tyre size		23.1-26 12PR	23.5-25 16PR
-----------------	--	--------------	--------------

Brakes

Service brake		hydrost.	hydrost.
Parking brake		hydromec.	hydromec.

Steering

Steering system		oscil.artic.	oscil.artic.
Steering method		hydrost.	hydrost.
Steering / oscillating angle +/-	grad	35/12	35/12

Exciter system

Frequency (1)	Hz	28	26
Amplitude (1)	mm	0 - 2,25	0 - 2,70
Centrifugal force 1	kN	365	500
Centrifugal force 1	t	37,2	51,0

Capacities

Fuel	l	250,0	280,0
------------	---	-------	-------

Technical modifications reserved. Machines may be shown with options.

Standard Equipment

- BOMAG ECOMODE
- BOMAG VARIOCONTROL
- TERRAMETER
- Oscillation mode
- Warning, information and operation displays with LCD
- Hydrostatic travel and vibration drive
- Hydrostatic articulated steering
- Articulated joint lock
- Rear axle with twin spring accumulator brakes
- Self locking differential
- Warning horn
- Single lever control for travel and vibration
- Seat with arm rest and adj. for position and height
- 2 Scrapers
- Emergency STOP
- Back-up alarm
- Working lights front / rear
- Double pump system for travel drive
- Loading mode
- Battery disconnect switch
- BOMAG TELEMATIC POWER

Optional Equipment

- ROPS/FOPS cabin with seat belts
 - Sliding window
- Air condition
- Rearview camera
- BOMAG ECOSTOP
- Padfoot segment kit
- Radio (Bluetooth)
- Indicator and hazard lights
- Special painting
- Rotary beacon
- Pre start cabin heating
- Comfort package: Adjustable seat and adjustable steering column
- Measuring- and machine data interface for third-party suppliers
- Reversing alarm buzzer with broad band audio
- LED Working lights (Cabin)
- Highly wear resistant drum

